

Enkelvoudige aansluitplaat (Gietstuk) Boorpatroon A6 DIN 24340 NG6 CETOP 03

P+T en A+B onderkant G1/2" 315 bar

Materiaal GG25

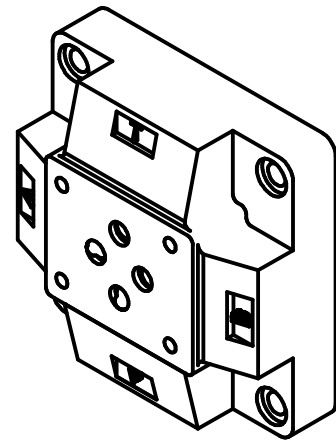
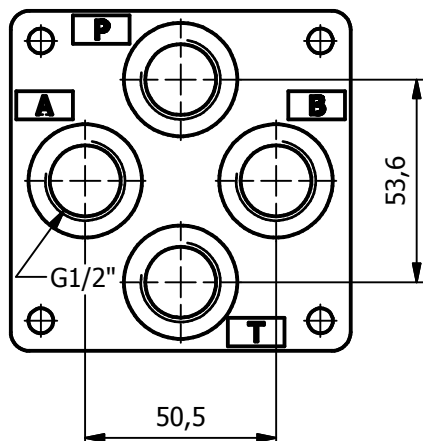
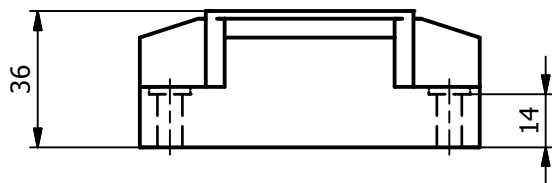
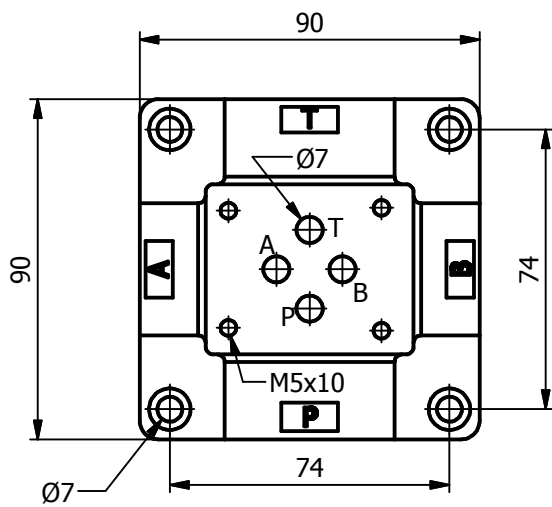

BEST.NR.
2901.00 G1/2" 1.5 kg

